

PROFIL LIGHT

LX-PL-LE1212



24V	CRI >80/95	PF >0.9	IP 20
-----	---------------	------------	----------



LX-PL-LE1212

Special local auxiliary lighting system, can be widely used in various interior decoration scenarios and local light spaces. A touch of auxiliary decorative lighting in addition to the basic lighting creates different atmospheres and visual enjoyment.

Embellish life with light that follows you whenever you go.



- 1, "Dots-free" lighting : Perfect homogenous lighting.
- 2, Various diffuser options : Several options of diffusers, In various shapes and light distribution plans Complete with everything needed
- 3, "Two" end caps : Two options of end cap for two ways of wire outgoing, Close-fitting design without screws makes installation much easier
- 4, Various installation methods : A wide range of installation accessories wider applications
- 5, "One" cut : Consistent length between diffuser and profile
- 6, Smart control for unlimited possibilities : Perfectly match the profiles like customized, Control by hand sweep or touching.



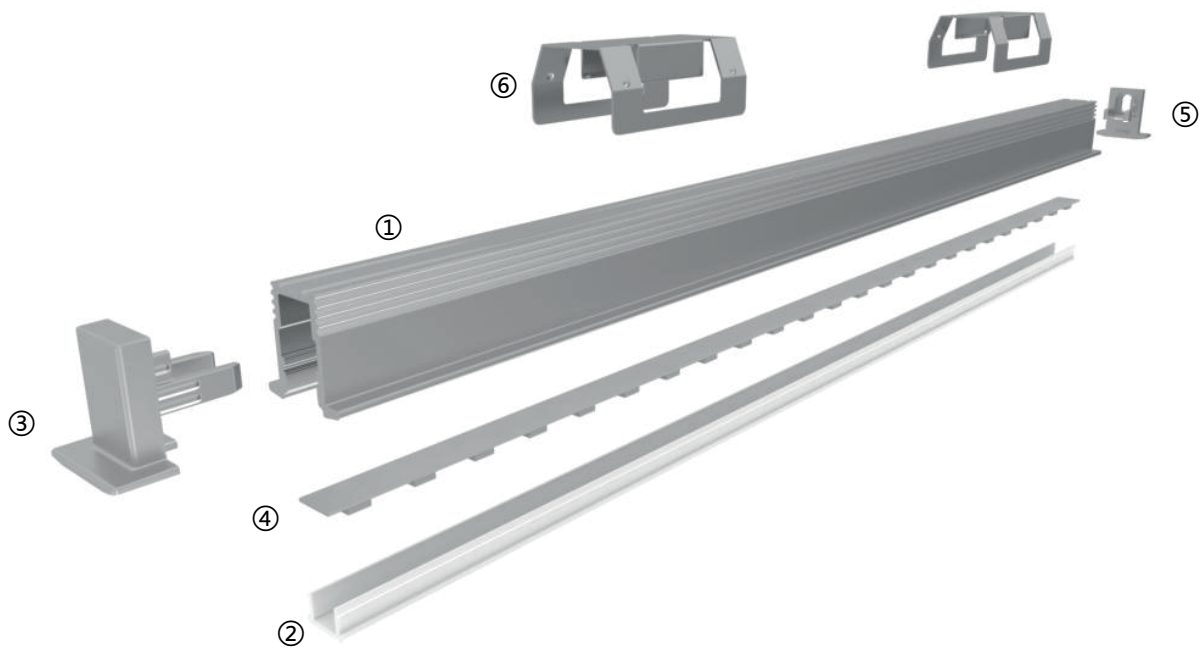



Details



Standard Configuration

Picture	Item	Parameter	Model
	① Profile	Material: AL6063-T5 Profile weight: 0.23kg/2.5m Size: L2500*W12*H12mm Surface processing: Anodizing	/
	② Cover	Type: Frosted diffuser Material: PC Light transmittance : 55% Size : L2500*W6.4*H3.7mm (shrink) 0.8mm/m when the temperature rises (drops) 10°C.	/
	③ End caps	Size : L12*W12*H10mm	LX-EC-LE1212

Optional Accessories

Picture	Item	Parameter	Model
	② Black Cover	Type: Microprism diffuser Material: PC Light transmittance : 50% Size : L2500*W14.6*H4.3mm (shrink) 0.8mm/m when the temperature rises (drops) 10°C.	LX-CV-LR1613
	⑤ End caps	Size : L12*W12*H10mm	LX-EC-LE1212
	④ FPC strip	Material : FPC, CCT : 2700/3000/4000/6000K ; Ra > 90; Voltage:24V ; Power : 6.6W/m ; Lumen : 710Lm/m ; PCB width : 4mm ; Minimum cut : 50mm ;	LX-ST-D6140-24V -4mm
	⑥ Recessed clips	Size : L25*W13*H9.5mm	LX-CP-11

Fixings



Dimensions

