

PROFIL LIGHT

LX-PL-LS0709



24V	CRI >80/95	PF >0.9	IP 20
-----	---------------	------------	----------



LX-PL-LS0709

Special local auxiliary lighting system, can be widely used in various interior decoration scenarios and local light spaces. A touch of auxiliary decorative lighting in addition to the basic lighting creates different atmospheres and visual enjoyment.

Embellish life with light that follows you whenever you go.

- 1, "Dots-free" lighting : Perfect homogenous lighting.
- 2, Various diffuser options : Several options of diffusers, In various shapes and light distribution plans Complete with everything needed
- 3, "Two" end caps : Two options of end cap for two ways of wire outgoing, Close-fitting design without screws makes installation much easier
- 4, Various installation methods : A wide range of installation accessories wider applications
- 5, "One" cut : Consistent length between diffuser and profile
- 6, Smart control for unlimited possibilities : Perfectly match the profiles like customized, Control by hand sweep or touching.





luxio
L I G H T I N G

www.luxio-lighting.com

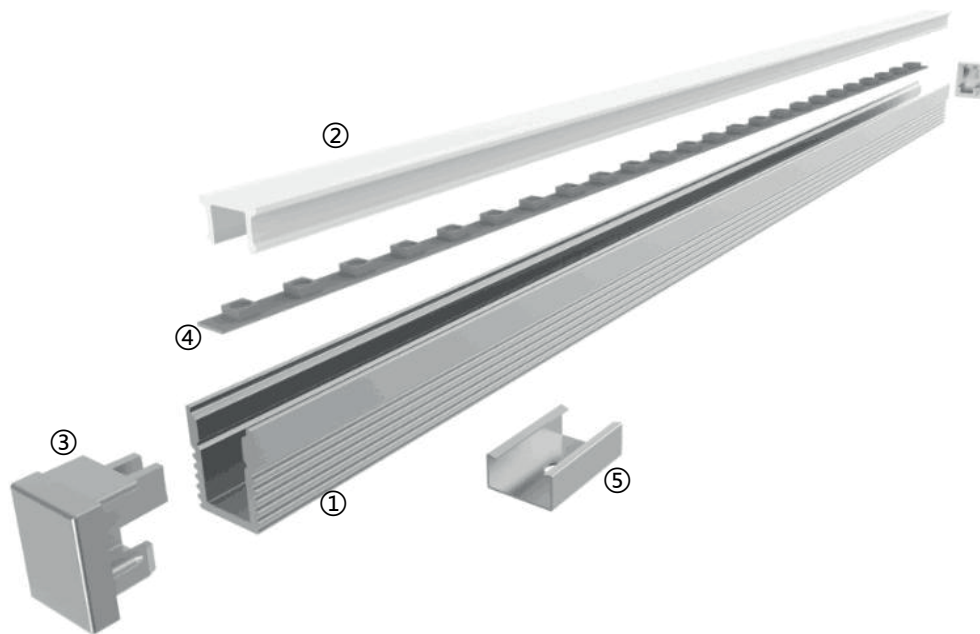

Details



Standard Configuration

Picture	Item	Parameter	Model
	①Profile	Material: AL6063-T5 Profile weight: 0.187kg/2.5m Size: L2500*W7.6*H9mm Surface processing: Silver alkali sand oxidation film	/
	②Cover	Type: Frosted diffuser Material: PC Light transmittance : 55% Size : L2500*W6.4*H3.7mm (shrink) 0.8mm/m when the temperature rises (drops) 10°C.	/
	③End caps	Size : L9*W7.6*H8mm	LX-EC-EC-LS0709

Optional Accessories

Picture	Item	Parameter	Model
	② Black Cover	Type: Black diffuser Material: PC Light transmittance : 15% Size : L2500*W6.4*H3.7mm (shrink) 0.8mm/m when the temperature rises (drops) 10°C.	LX-CV-M-LR0812
	④ FPC strip	Material : FPC, CCT : 2700/3000/4000/6000K ; Ra>90; Voltage:24V ; Power : 6.6W/m ; Lumen : 710Lm/m ; PCB width : 4mm ; Minimum cut : 50mm ;	LX-ST-D6140-24V-4mm
	⑤ Recessed clips	Size : L15*W9.7*H4.5mm	LX-CP-03

Fixings



Dimensions

