

PROFIL LIGHT

LX-PL-LS1607



24V	CRI >80/95	PF >0.9	IP 20
-----	---------------	------------	----------



LX-PL-LS1607

Special local auxiliary lighting system, can be widely used in various interior decoration scenarios and local light spaces. A touch of auxiliary decorative lighting in addition to the basic lighting creates different atmospheres and visual enjoyment.

Embellish life with light that follows you whenever you go.

- 1, "Dots-free" lighting : Perfect homogenous lighting.
- 2, Various diffuser options : Several options of diffusers, In various shapes and light distribution plans Complete with everything needed
- 3, "Two" end caps : Two options of end cap for two ways of wire outgoing, Close-fitting design without screws makes installation much easier
- 4, Various installation methods : A wide range of installation accessories wider applications
- 5, "One" cut : Consistent length between diffuser and profile
- 6, Smart control for unlimited possibilities : Perfectly match the profiles like customized, Control by hand sweep or touching.

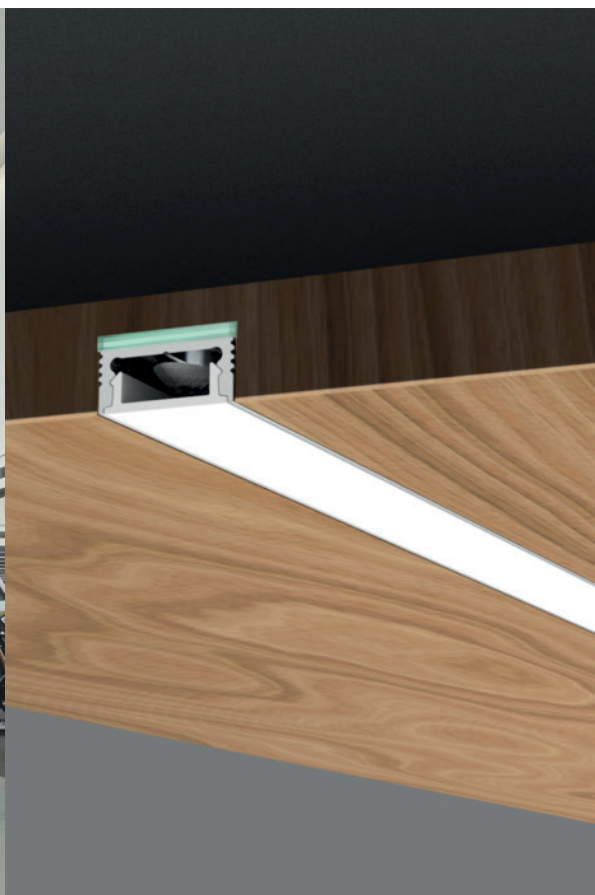



luxio
L I G H T I N G

www.luxio-lighting.com

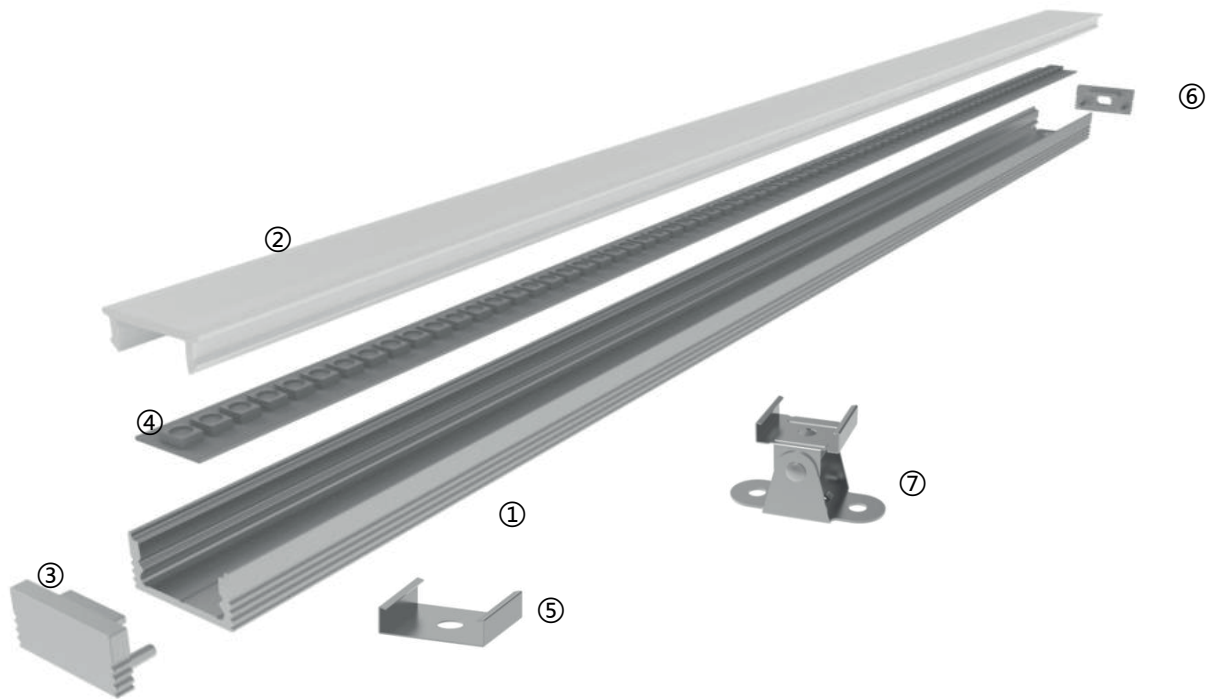



Details



Standard Configuration

Picture	Item	Parameter	Model
	①Profile	Material: AL6063-T5 Profile weight: 0.22kg/2.5m Size: L2500*W16*H7mm Surface processing: Anodizing	/
	②Cover	Type: Frosted diffuse Material: PC Light transmittance : 60% Size : L2500*W14.7*H4.5mm (shrink) 0.8mm/m when the temperature rises (drops) 10°C.	/
	③End caps	Size : L16*W7*H6mm	LX-EC-LS1607

Optional Accessories

Picture	Item	Parameter	Model
	② Microprism diffuser	Type: Microprism diffuser Material: PC Light transmittance : 65% Size : L2500*W14.7*H4.5mm (shrink) 0.8mm/m when the temperature rises (drops) 10°C.	LX-CV-M-LR1613
	② Black Microprism	Type: Black Microprism Material: PC Light transmittance : 15% Size : L2500*W14.7*H4.5mm (shrink) 0.8mm/m when the temperature rises (drops) 10°C.	LX-CV-B-LR1613
	④ FPC strip	Material : FPC, CCT : 2700/3000/4000/6000K ; Ra>90; Voltage:24V ; Power : 15W/m ; Lumen : 1650Lm/m ; PCB width : 8mm ; Minimum cut : 25mm ;	LX-ST-D6280-24V- 8mm
	⑤ Recessed clips	Size : L17.8*W15*H4.5mm	LX-CP-04
	⑥ End cap with hole	Size : L16*W7*H6mm	LX-EC-LS1607
	⑦ 0-180° adjustable installation clip	Size : L35*W17.7*H21.4mm	LX-CP-06

Fixings

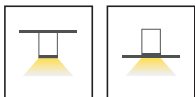

Dimensions

