

PROFIL LIGHT

LX-PL-LS2013



24V	CRI >80/95	PF >0.9	IP 20
-----	---------------	------------	----------



LX-PL-LS2013

Special local auxiliary lighting system, can be widely used in various interior decoration scenarios and local light spaces. A touch of auxiliary decorative lighting in addition to the basic lighting creates different atmospheres and visual enjoyment.

Embellish life with light that follows you whenever you go.



- 1, "Dots-free" lighting : Perfect homogenous lighting.
- 2, Various diffuser options : Several options of diffusers, In various shapes and light distribution plans Complete with everything needed
- 3, "Two" end caps : Two options of end cap for two ways of wire outgoing, Close-fitting design without screws makes installation much easier
- 4, Various installation methods : A wide range of installation accessories wider applications
- 5, "One" cut : Consistent length between diffuser and profile
- 6, Smart control for unlimited possibilities : Perfectly match the profiles like customized, Control by hand sweep or touching.



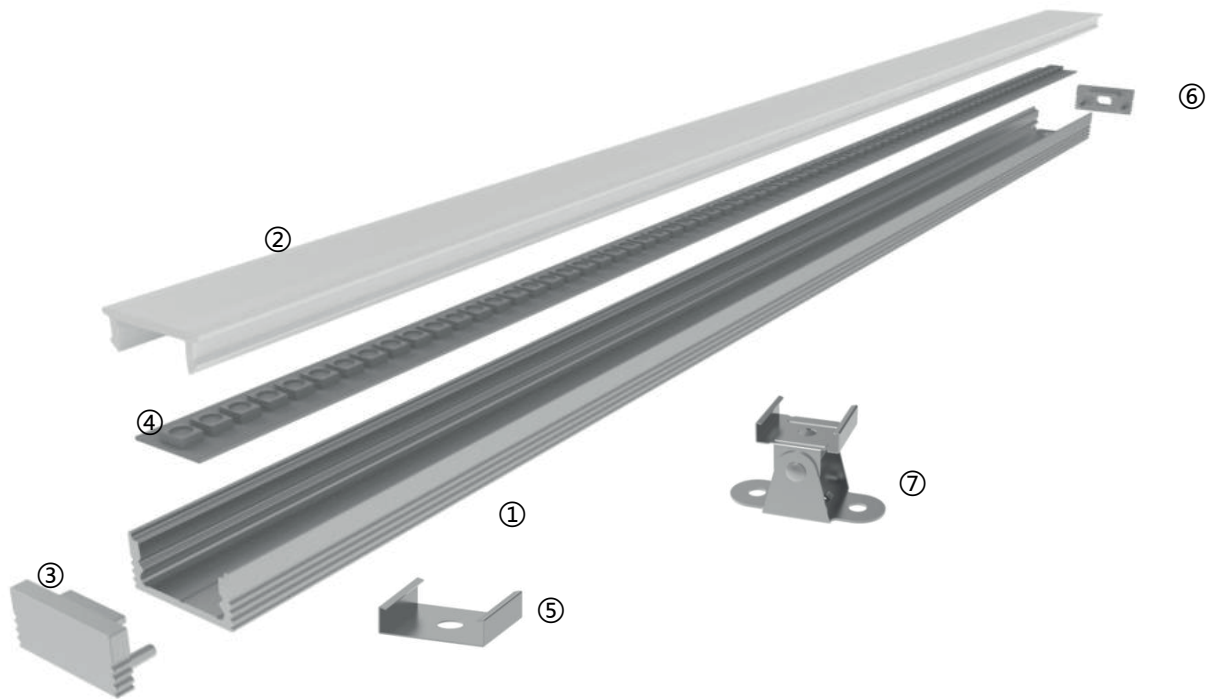



Details



Standard Configuration

Picture	Item	Parameter	Model
	① Profile&Carrier	Material: AL6063-T5 Profile weight: 0.473kg/2.5m Size: L2500*W20*H13mm Surface processing: Anodizing	/
	②Cover	Type: Frosted diffuser Material: PC Light transmittance : 60% Size : L2500*W16.7*H7.8mm (shrink) 0.8mm/m when the temperature rises(drops) 10°C.	/
	③End caps	Size : L20*W13*H4.5mm	LX-EC-LS2013

Optional Accessories

Picture	Item	Parameter	Model
	②Microprism diffuser	Type: Microprism diffuser Material: PC Light transmittance: 65% Size: L2500*W16.7*H7.8mm (shrink) 0.8mm/m when the temperature rises (drops) 10°C.	LX-CV-LR2013
	②Black Microprism	Type: Black Microprism Material: PC Light transmittance: 7% Size: L2500*W16.7*H7.8mm (shrink) 0.8mm/m when the temperature rises (drops) 10°C.	LX-CV-LR2013
	③End cap with hole	Size: L20*W13*H4.5mm	LX-EC-LS2013
	④FPC strip LX-ST-D6280-24V -10mm	Material: FPC, CCT: 2700/3000/4000/6000K; Ra > 90; Voltage:24V; Power: 15W/m; Lumen: 1508Lm/m; PCB width: 10mm; Minimum cut: 50mm;	LX-ST-D6280-24V -10mm
	⑤Clips	Size: L21.8*W12*H6.4mm	LX-CP-08

Fixings



Dimensions

