

PROFIL LIGHT



LX-PL-LS2020

24V	CRI >80/95	PF >0.9	IP 20
-----	---------------	------------	----------



LX-PL-LS2020

Special local auxiliary lighting system, can be widely used in various interior decoration scenarios and local light spaces. A touch of auxiliary decorative lighting in addition to the basic lighting creates different atmospheres and visual enjoyment.

Embellish life with light that follows you whenever you go.

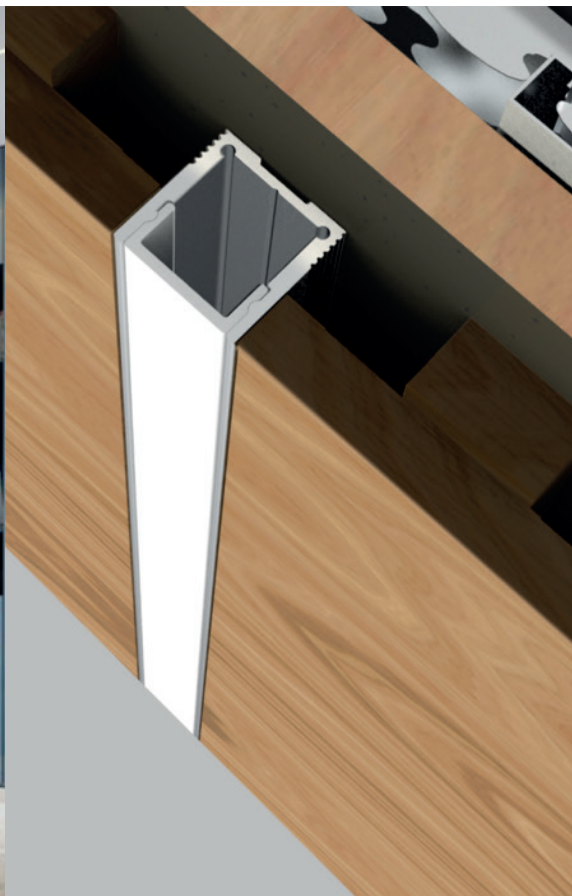

- 1, "Dots-free" lighting : Perfect homogenous lighting.
- 2, Various diffuser options : Several options of diffusers, In various shapes and light distribution plans Complete with everything needed
- 3, "Two" end caps : Two options of end cap for two ways of wire outgoing, Close-fitting design without screws makes installation much easier
- 4, Various installation methods : A wide range of installation accessories wider applications
- 5, "One" cut : Consistent length between diffuser and profile
- 6, Smart control for unlimited possibilities : Perfectly match the profiles like customized, Control by hand sweep or touching.



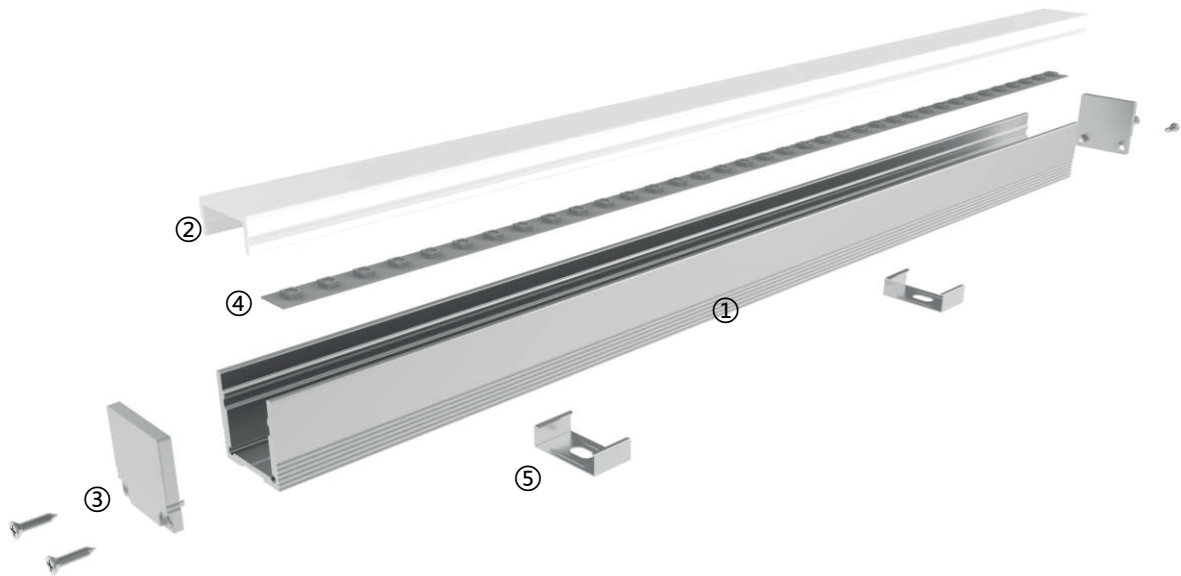



Details



Standard Configuration

Picture	Item	Parameter	Model
	①Profile	Material: AL6063-T5 Profile weight: 0.7kg/2.5m Size: L2500*W20*H20mm Surface processing: Anodizing	/
	②Cover	Type: Frosted diffuser Material: PC Light transmittance : 60% Size : L2500*W16.7*H7.8mm (shrink) 0.8mm/m when the temperature rises (drops) 10°C.	/
	③End caps	Size : L20*W20*H4.5mm	LX-EC-LS2020

Optional Accessories

Picture	Item	Parameter	Model
	Microprism diffuser	Type: Microprism diffuser Material: PC Light transmittance : 65% Size : L2500*W16.7*H7.8mm (shrink) 0.8mm/m when the temperature rises (drops) 10°C.	LX-CV-M-LR2013
	Black Microprism	Type: Black Microprism Material: PC Light transmittance : 7% Size : L2500*W16.7*H7.8mm (shrink) 0.8mm/m when the temperature rises (drops) 10°C.	LX-CV-B-LR2013
	FPC strip	Material : FPC, CCT : 2700/3000/4000/6000K ; Ra>90; Voltage:24V ; Power : 15W/m ; Lumen : 1508Lm/m ; PCB width : 10mm ; Minimum cut : 50mm ;	LX-D6280-24V- 10mm
	End cap with hole	Size : L20*W20*H4.5mm	LX-EC-LS2020
	Recessed clips	Size : L21.8*W12*H6.4mm	LX-CP-08

Fixings

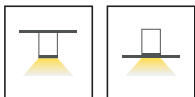

Dimensions

