

STRIP LED

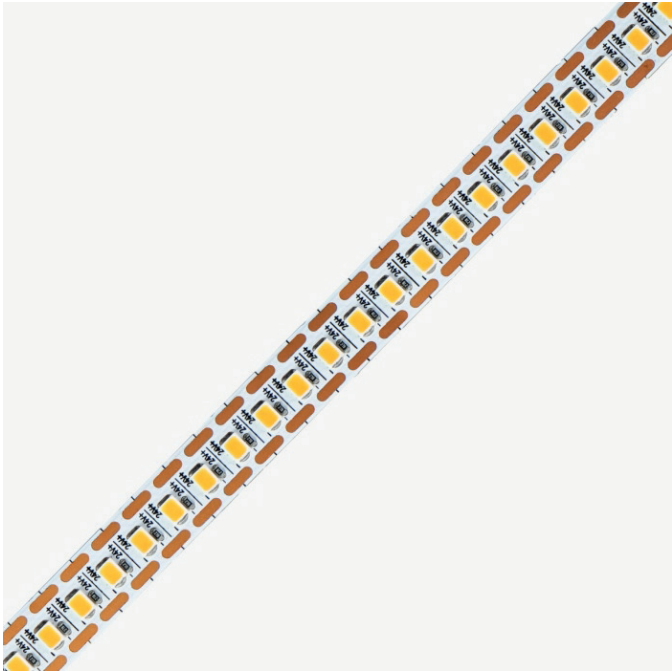

LX-ST-D8168N-24V-10mm

IP	CRI	DC24V
20/65/67	>90	



- 24V single lamp cut for more flexible application
- Mini cut unit up to 5.95mm
- Parameter matches with traditional ones, better for stock management
- Self-encapsulated design offers 5 optional 2300-6000K white lights
- Rated current : 0.68A(1m) 2.53A(5m)
- On-off times: 10000 (test times)
- Max.length : 5000mm(16.4')
- Cutting unit : : 1leds/5.95mm(0.23")
- Min. bend diameter : Φ 60mm(2.36")
- Mounting : 3M tape
- Copper foil: 3oz

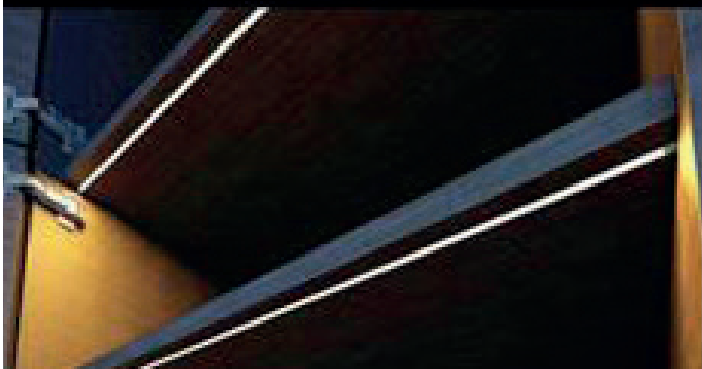
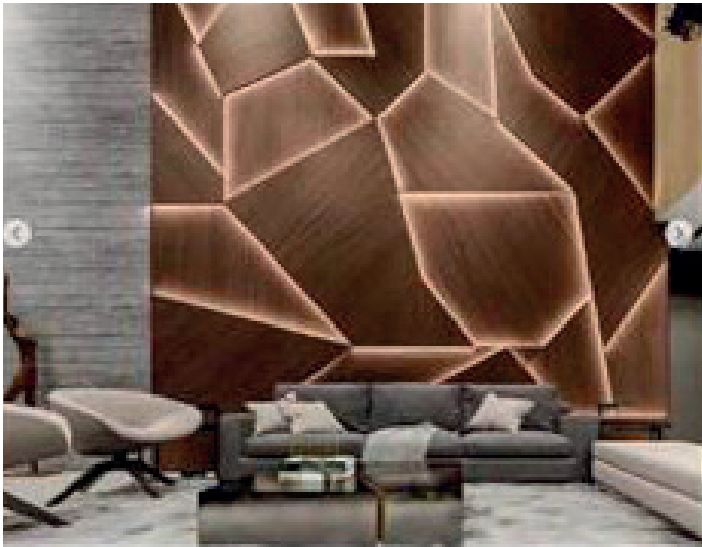

luxio
L I G H T I N G

www.luxio-lighting.com

References



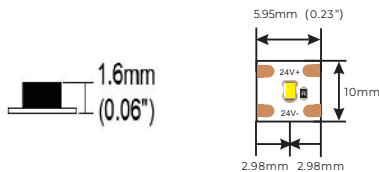

Reference	Typical Power	Max Power	Luminous flux/m	CRI	CCT/K	IP Rating	Dimensions
LX-ST-D8168N-24V -10mm	16.2W/(1m) & 60.8W/(5m)	18.6W(1m)	1340lm	Ra>90	2300K	IP20/65/67	5000*10*1.6mm
			1295lm		2700K		
			1380lm		3000K		
			1465lm		4000K		
			1510lm		6000K		

- 1.The tolerance of output data can be vary up to 15%.
- 2.the output data tested according to IES TM-30-15.
- 3.the output data is based on IP20/1 merter, data of 5m in only for reference.
- 4.IP protection process leads changes to size, CCT and luminous flux.









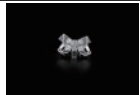
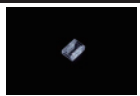

Dimensions

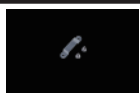

Electronic & output data

IP Process	Picture	Picture description	Size	Optional CCT/color for finished product	Lumen output rate
NO		No proof	8mm*1.5mm	2300K/2700K/3000K/4000K/6000K	100%
NA		Nano-proof	8mm*1.5mm	2300K/2700K/3000K/4000K/6000K	98%
ET		Extrusion tube	10mm*4.8mm	2300K/2700K/3000K/4000K/6000K	88%
ETS		Extrusion tube	10mm*4.8mm	2300K/2700K/3000K/4000K/6000K	88%

Accessories Information

Name	Picture	Code	coding	description
Connector for wire and FPC		94-42-620800001	LX-TXB208-NOGA	8mm width, 2PIN connector of wire and FPC, suitable for white color strip, NO/NA, 2PIN wire 18- 22AWG
Connector for FPC and FPC		94-42-620800002	LX-TBB208-NOGA	8mm width, 2PIN connector of FPC and FPC, suitable for white color strip, NO/NA
Slim connector		81-01-000000-000064	LX-TBB208-NOTA	Suitable for 8mm board width, IP20, 2PIN board-to-board solderless terminal
Slim connector		81-01-000000-000066	LX-TXB208-NOTA012	Suitable for 8mm board width, IP20, 2PIN wire- to-board solderless terminal
Fixed Clip		94-02-00-0002	LX-FSW08SA	Silicone clip, screw: PA 3*8mm, suitable for 8mm FPC, EF/ET strip
ET press-fit terminals		94-03-00-0027	LX-PT208-ETWA	Monochromatic light strip, 8mm board width, ETS protection technology
ET press-fit terminals		94-03-00-0028	LX-CBX208-ETWA020	Monochromatic light strip, 8mm board width, ETS protection technology
ET press-fit terminal kit		94-03-00-0029	LX-STBX208-ETWA020	Monochromatic light strip, 8mm board width, ETS protection technology
Silicone Plug Kit		94-02-00-0044	LX-DT08EA-A	Silicone plug kit, suitable for 8mm board width, ET/EF series silicone extrusion light strip
Silicone stopper kit		94-02-00-0045	LX-DW08EA-A	Silicone tail plug kit, suitable for 8mm board width, ET/EF series silicone extrusion light strip
Mounting groove		94-02-00-0024	LX-CVT08EA-12100100	Transparent PVC mounting groove, suitable for 8mm FPC, silicone extruded EF/ET strip
Stopper glue		94-16-03010001	LX-AS-PG-0003	Silicone gel, suitable for ET/EF/EG waterproof LED strip

IP process information

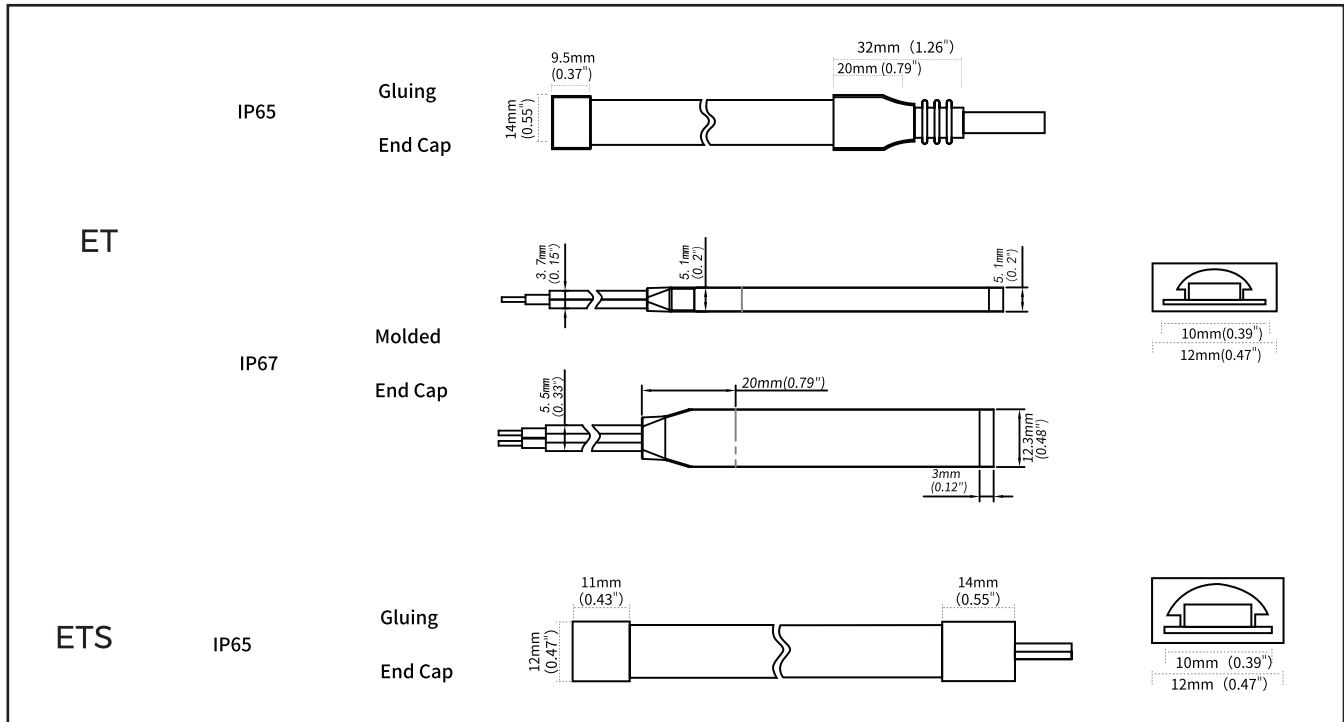

Precautions

- Please drive the led strip with 24VDC isolated power, and the ripple of the constant voltage source should be less than 5%.
- Please do not bend the strip into an arc with a diameter less than 60mm to ensure the longevity and reliability.
- Do not fold it in case any damage of LED beads.
- Do not pull the power wire hard to ensure the longevity. Any Crash may damage the LED light is prohibited.
- Please make sure the wire is connected to the anode and cathode correctly. The power output should be consistent with the voltage of the strip to avoid damage.
- LED lights should be stored in dry, sealed environment. Please only unpack it before usage. Ambient temperature: -250°C~400°C
- Storage temperature: 0°C~600°C. Please use the strips without waterproof within indoor environment with humidity less than 70%.
- Please be careful during operation. Do not touch the AC power supply in case of electric shock.
- Please leave at least 20% power for the power supply during using to ensure there is enough power supply to drive the product.
- Do not use any acid or alkaline adhesives to fix the product (e.g.: glass cement).
- Do not scratch the product when IP process of the product is NA. Ultraviolet rays will damage the nano-layers on the product and seriously affect the life of the product.