

PROFIL LIGHT

LX-PL-LE25LA



| | | | |
|-----|---------------|----------|------------|
| 24V | CRI >80/90 | IP 20 | SDCM ≤3 |
|-----|---------------|----------|------------|



LX-PL-LE25LA

- 25mm slender lighting surface
- 120 LM/W high light efficiency design, lumen output up to 2375 Lm/m
- Butterfly clip design, more convenient installation.
- CCT :2700K/3000K/3500K/4000K/5000K/6500K
- Dimming method: no power supply
- Lighting direction: downward
- Length: 200mm/600mm/1200mm/1500mm/1800mm/2400mm optional (other length on request)
- Coating: Black (RAL9005), White (RAL9003)
- Installation: Recessed









Optical & electronic data

| | 200mm (0.66') | 600mm (2') | 1200mm (4') | 1500mm (5') | 1800mm (6') | 2400mm (8') |
|--|------------------|---------------|----------------|----------------|----------------|----------------|
| Asymmetric  | 6W / 712LM | 12W / 1425LM | 24W / 2850LM | 30W / 3562LM | 36W / 4275LM | 48W / 5700LM |

Remark:

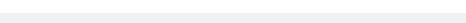
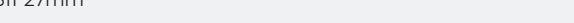
- 1,the tolerance of output data can be vary up to 10%;
- 2,the output data is typical value;

Standard length

| |
|--|
| <p>200mm (0.66') </p> <p>Opening size:211*27mm</p> |
| <p>600mm (2') </p> <p>Opening size:611*27mm</p> |
| <p>1200mm (4') </p> <p>Opening size:1211*27mm</p> |
| <p>1500mm (5') </p> <p>Opening size:1511*27mm</p> |
| <p>1800mm (6') </p> <p>Opening size:1811*27mm</p> |
| <p>2400mm (8') </p> <p>Opening size:2411*27mm</p> |
| <p>Customized length (2400mm ~ 5000mm) (7.87' ~ 16.4')</p>  |
| <p>Ultra long connection (<5000mm) (<16.4')</p>  |

Dimensions

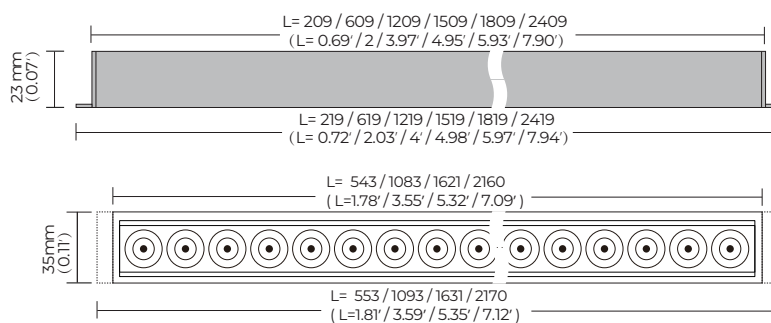

Corners

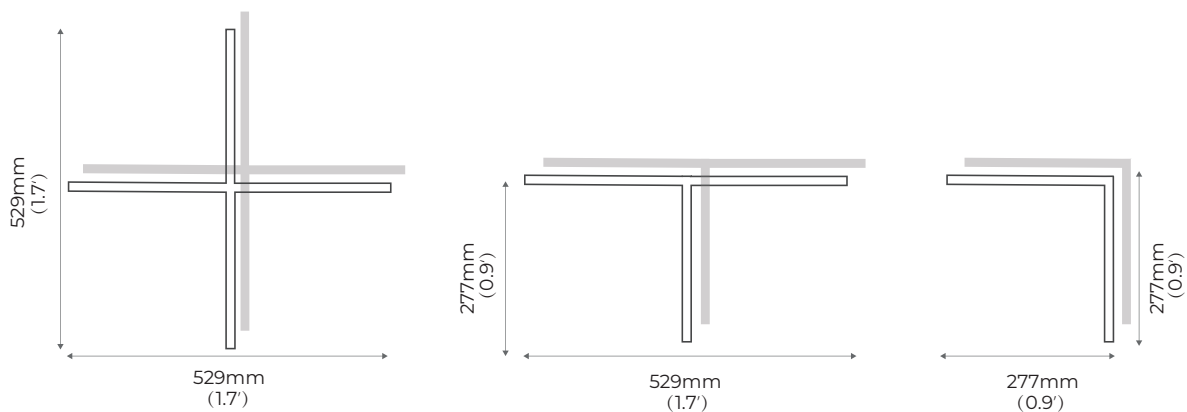

Lighting effect

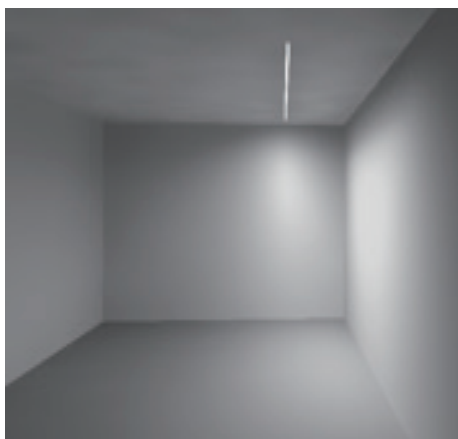

Asymmetric