

PROFIL LIGHT

LX-PL-LH25G(A)

24V	CRI >80/95	IP 20
-----	---------------	----------



LX-PL-LH25G(A)

- Up and down lighting design with suspension way, 25mm slender lighting surface
- 95 Lm/W high light efficiency design, lumen output up to 3800 Lm/m
- Multiple standard corner (L type, X type, T type optional), available for free connection.
- Electric wire & suspension wire with two-in-one design, invisible and beautiful.

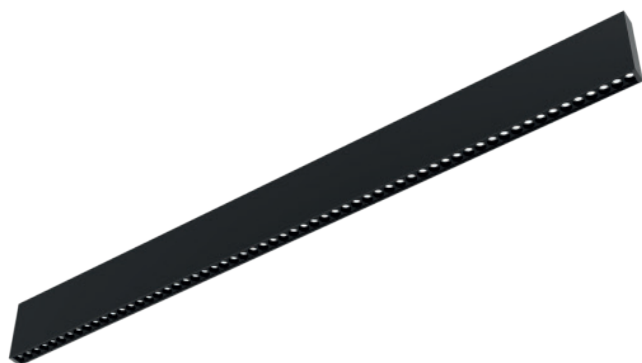

luxio
L I G H T I N G

www.luxio-lighting.com

Optical & electronic data

	550mm (1.8')	1100mm (3.6')	1600mm (5.2')	1800mm (6')	2200mm (7.2')	L*(277*277mm) (1'x1')	T*(529*277mm) (1.7'x1')	X*(529*529mm) (1.7'x1.7')
Round Grating 30°55° 	Up:10W/750LM Down:10W/750LM	Up:20W/1500LM Down:20W/1500LM	Up:30W/2250LM Down:30W/2250LM	/	Up:40W/3000LM Down:40W/3000LM	/	/	/

Remark:

- 1,the tolerance of output data can be vary up to 10%;
- 2,the output data is typical value;

Standard length

550mm (1.8') 

1100mm (3.6') 

1600mm (5.2') 

2200mm (7.2') 

Customized length (2400mm ~ 5000mm) (7.87' ~ 16.4')



Ultra long connection (<5000mm) (<16.4')



Dimensions

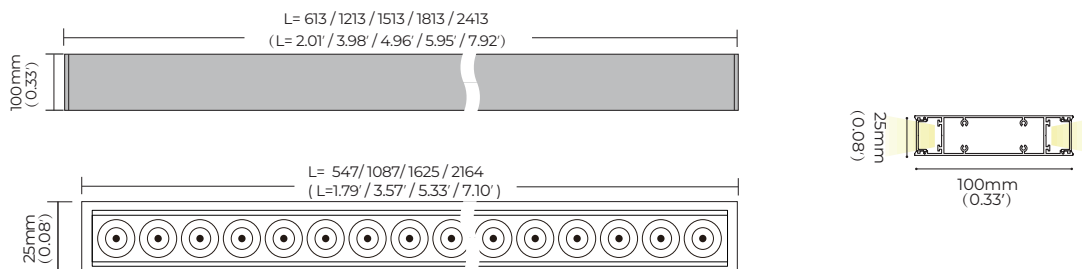

Corners

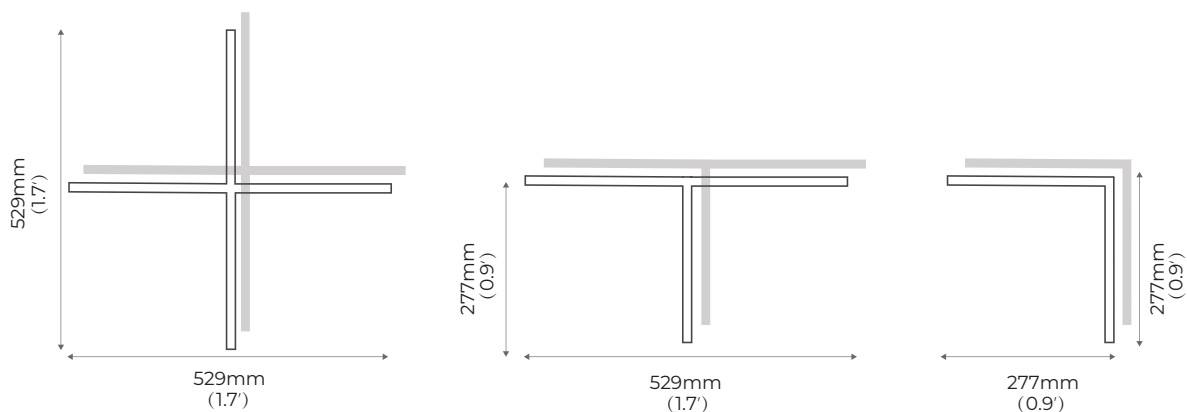

Lighting effect

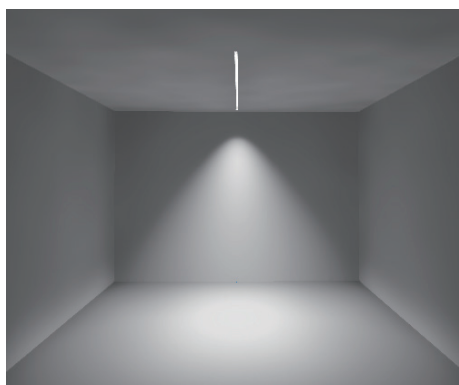

Round Grating 30°

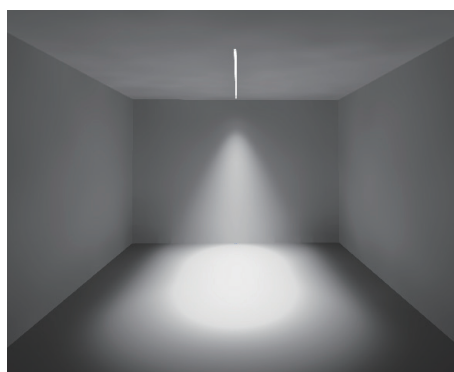

Round Grating 55°